



---

## Getting Started with HFSS: RCS



ANSYS Product Suite

ANSYS, Inc.

275 Technology Drive  
Canonsburg, PA 15317

Tel: (+1) 724-746-3304

Fax: (+1) 724-514-9494

General Information: [AnsoftInfo@ansys.com](mailto:AnsoftInfo@ansys.com)

Technical Support: [AnsoftTechSupport@ansys.com](mailto:AnsoftTechSupport@ansys.com)

May 2010

Inventory \*\*\*\*\*

The information contained in this document is subject to change without notice. Ansoft makes no warranty of any kind with regard to this material, including, but not limited to, the implied warranties of merchantability and fitness for a particular purpose. Ansoft shall not be liable for errors contained herein or for incidental or consequential damages in connection with the furnishing, performance, or use of this material.

© 2010 SAS IP Inc., All rights reserved.

ANSYS, Inc.

275 Technology Drive

Canonsburg, PA 15317

USA

Tel: (+1) 724-746-3304

Fax: (+1) 724-514-9494

General Information: [AnsoftInfo@ansys.com](mailto:AnsoftInfo@ansys.com)

Technical Support: [AnsoftTechSupport@ansys.com](mailto:AnsoftTechSupport@ansys.com)

HFSS and Optimetrics are registered trademarks or trademarks of SAS IP Inc.. All other trademarks are the property of their respective owners.

New editions of this manual incorporate all material updated since the previous edition. The manual printing date, which indicates the manual's current edition, changes when a new edition is printed. Minor corrections and updates that are incorporated at reprint do not cause the date to change.

Update packages may be issued between editions and contain additional and/or replacement pages to be merged into the manual by the user. Pages that are rearranged due to changes on a previous page are not considered to be revised.

Edition	Date	Software Version
1	February 2009	12
2	September 2010	13.0

## Conventions Used in this Guide

Please take a moment to review how instructions and other useful information are presented in this guide.

*Alternate methods or tips are listed in the left margin in blue italic text.*

- Procedures are presented as numbered lists. A single bullet indicates that the procedure has only one step.
- Bold type is used for the following:
  - Keyboard entries that should be typed in their entirety exactly as shown. For example, “**copy file1**” means to type the word **copy**, to type a space, and then to type **file1**.
  - On-screen prompts and messages, names of options and text boxes, and menu commands. Menu commands are often separated by carats. For example, click **HFSS>Excitations>Assign>Wave Port**.
  - Labeled keys on the computer keyboard. For example, “Press **Enter**” means to press the key labeled **Enter**.
- Italic type is used for the following:
  - Emphasis.
  - The titles of publications.
  - Keyboard entries when a name or a variable must be typed in place of the words in italics. For example, “*copy file name*” means to type the word **copy**, to type a space, and then to type a file name.
- The plus sign (+) is used between keyboard keys to indicate that you should press the keys at the same time. For example, “Press **Shift+F1**” means to press the **Shift** key and the **F1** key at the same time.
- Toolbar buttons serve as shortcuts for executing commands. Toolbar buttons are displayed after the command they execute. For example,
 

“On the **Draw** menu, click **Line**  ” means that you can click the Draw Line toolbar button to execute the **Line** command.

## Getting Help

### Ansoft Technical Support

To contact Ansoft technical support staff in your geographical area, please log on to the Ansoft corporate website, <http://www.ansoft.com>, click the **Contact** button, and then click **Support**. Phone numbers and e-mail addresses for the technical support staff are listed. You can also contact your Ansoft account manager in order to obtain this information.

All Ansoft software files are ASCII text and can be sent conveniently by e-mail. When reporting difficulties, it is extremely helpful to include very specific information about what steps were taken or what stages the simulation reached, including software files as applicable. This allows more rapid and effective debugging.

### Help Menu

To access online help from the HFSS menu bar, click **Help** and select from the menu:

- **Contents** - click here to open the contents of the online help.
- **Search** - click here to open the search function of the online help.
- **Index** - click here to open the index of the online help.

### Context-Sensitive Help

To access online help from the HFSS user interface, do one of the following:

- To open a help topic about a specific HFSS menu command, press **Shift+F1**, and then click the command or toolbar icon.
- To open a help topic about a specific HFSS dialog box, open the dialog box, and then press **F1**.

# Table of Contents

## 1. Introduction

RCS Model .....	1-2
General Procedure .....	1-4

## 2. Create the RCS Model

Create the New Project .....	2-2
Add the New Project .....	2-2
Insert an HFSS Design .....	2-2
Add Project Notes .....	2-3
Save the Project .....	2-3
Select the Solution Type .....	2-5
Set Up the Drawing Region .....	2-5
Coordinate System Settings .....	2-5
Units Settings .....	2-6
Create the Geometries .....	2-7
Create the Target Box .....	2-7
Set the Properties for the Target Box .....	2-7
Create the Air Box .....	2-8
Set the Properties for the Air Box .....	2-8
Create the PML Boundaries .....	2-9
Seed the Mesh on the Airbox .....	2-13

Add the Incident Plane Wave .....	2-14
<b>3. Set Up and Generation Solutions</b>	
Add a Solution Setup to the Design .....	1-2
Validate the Design .....	1-3
Analyze the Design .....	1-3
View the Solution Data .....	1-4
View the Profile Data .....	1-4
<b>4. Post Processing for RCS</b>	
Creating the Far Field Infinite Sphere Setups ..	1-2
Creating the Monostatic Setup .....	1-3
Creating the Bistatic Setup .....	1-5
Creating a Far-Field Plot for Bistatic RCS .....	1-6
Creating a Plot for Monostatic RCS .....	1-9

# 1

## Introduction

This *Getting Started* guide is written for HFSS users who are modeling Radar Cross Section (RCS) in version 13 for the first time. This guide leads you step-by-step through creating, solving, and analyzing the results of a model that computes RCS.

By following the steps in this guide, you will learn how to perform the following tasks in HFSS:

- ✓ Draw the geometric models.
- ✓ Create the Perfectly Matched Layer (PML) Boundaries
- ✓ Add the Excitation
- ✓ Setup Mesh Operations
- ✓ Specify solution setting for the design.
- ✓ Validate the design setups.
- ✓ Run HFSS simulations.
- ✓ Create 2D x-y plots.

## RCS Model

The model for this simulation consists of a perfect electric conducting (pec) target cube surrounded by an airbox. The airbox is surrounded by a PML boundary. The excitation is a regular plane wave. The model has been kept fairly simple, to keep the solution time short. The purpose is to illustrate the basic principles in setting up this kind of problem, and to demonstrate post processing for the RCS information.

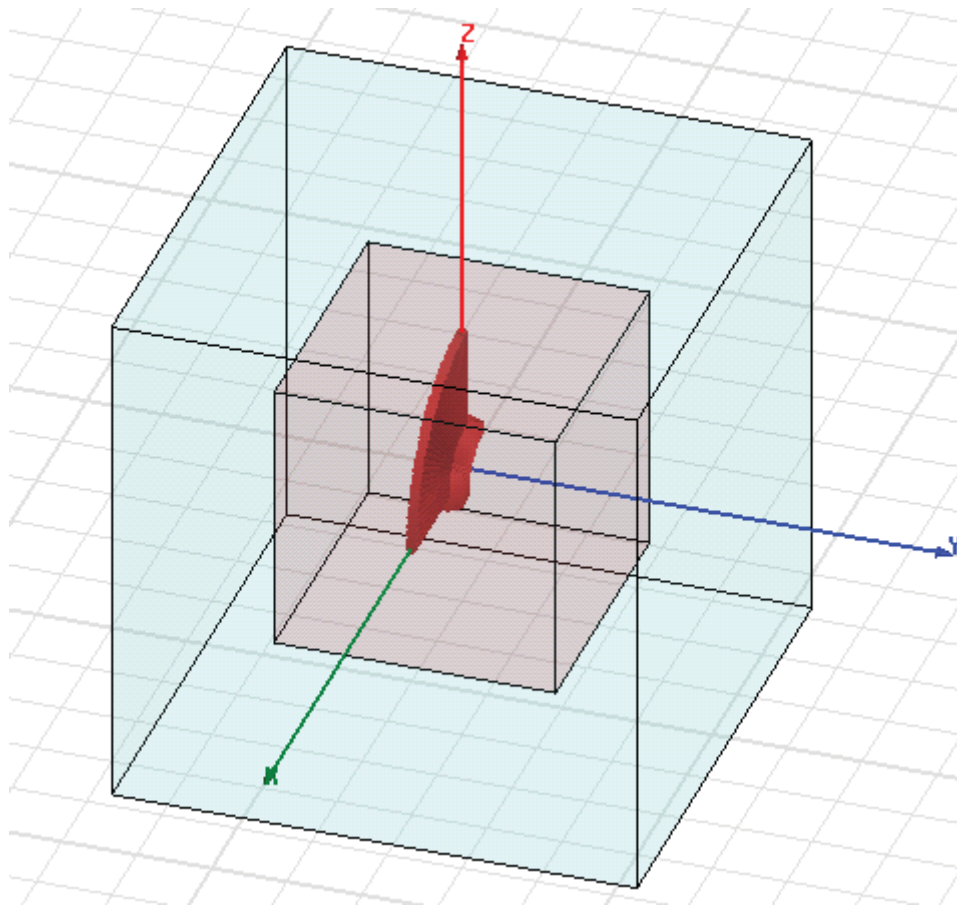

The radar cross-section (RCS) or echo area,  $\sigma$ , is measured in meters squared and represented for a bistatic arrangement (that is, when the transmitter and receiver are in different locations as shown in the linked figure).



The following diagram shows the bistatic RCS concept, with separate transmitting and receiving antennas.

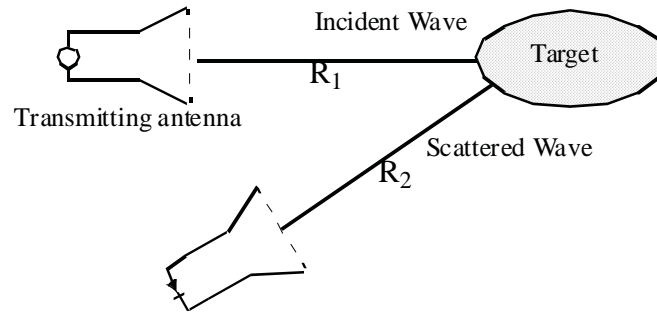

HFSS supports RCS for Bistatic, Normalized Bistatic, Complex Bistatic, and Monostatic conditions. In this tutorial, you will generate plots for Normalized Bistatic and Monostatic situations.

## General Procedure

The general procedure for creating and analyzing this RCS project is summarized in the following list:

- 1** Create a project for HFSS.
  - a. Open a new project.
  - b. Add an HFSS design into the new project.
- 2** Draw the geometric model; in this case, a target, and a surrounding airbox that is at least  $\lambda/4$  from the target.
  - a. Set up the drawing region.
  - b. Create the objects that make up the RCS model.
  - c. Assign materials to the objects. in this case pec for the target and vacuum for the air box.
- 3** Set up the problem:
  - a. Set up the PML boundary conditions.
  - b. Set up the plane wave excitation.
- 4** Generate a solution:
  - a. Set up the solution criteria and refine the mesh.
  - b. Generate the solution.
- 5** Use Post Processing to Analyze the RCS solution.

# 2

## Create the RCS Model

This section shows how to create the simple RCS model. The major steps are as follows.

- ✓ Create a New Project
- ✓ Create the Geometries
- ✓ Create the PML Boundaries
- ✓ Seed the Mesh
- ✓ Add the Incident Plane wave.

## Create the New Project

The first step in using HFSS to solve a problem is to create a project in which to save all the data associated with the problem. By default, opening HFSS 11 creates a new project named *Project $n$*  and inserts a new project named *HFSS-Design $n$* , where  $n$  is the order in which each was added to the current session.

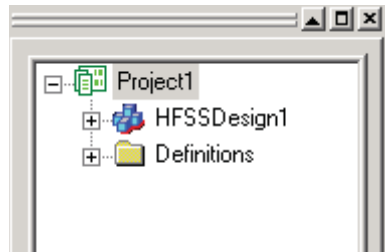

You can also create a new project and insert a design manually as follows.

## Add the New Project

To add a new HFSS project:

- Click **File>New**.

A new project is listed in the project tree in the **Project Manager** window. It is named *project $n$*  by default, where  $n$  is the order in which the project was added to the current session. Project definitions, such as boundaries and material assignments, are stored under the project name in the project tree.

## Insert an HFSS Design

The next step for this waveguide combiner problem is to insert an HFSS design into the new project. By default, a design named *HFSSDesign $n$*  with the type as [Driven Modal] appears for the current project.

To manually insert an HFSS design into the project, do one of the following:

- Click **Project>Insert HFSS Design**.
- Right-click on the project name in the **Project Manager** window, and then click **Insert>Insert HFSS Design** on the

shortcut menu.

- Click the Insert HFSS Design toolbar button .

A 3D Modeler window appears on the desktop and an HFSS Design icon is added to the project tree, as shown below:

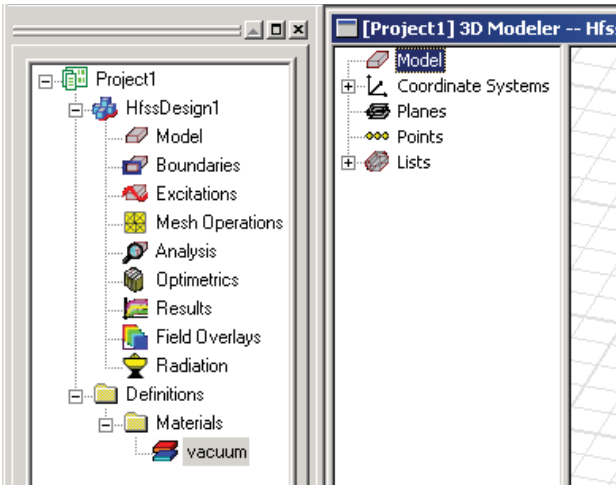

### Add Project Notes

Next, enter notes about your project, such as its creation date and a description of the device being modeled. This is useful for keeping a running log on the project.

To add notes to the project:

- 1 Click HFSS>Edit Notes.  
The Design Notes window appears.
- 2 Click in the window and type your notes, such as a description of the model and the version of HFSS in which it is being created.
- 3 Click OK to save the notes with the current project.

**Note** To edit existing project notes, double-click **Notes** in the project tree. The **Design Notes** window appears, in which you can edit the project's notes.

### Save the Project

Next, save and name the new project.

It is important to save your project frequently. Depending on the setting in **Tools>Options>HFSS General Options** dialog, **Project Options** tab, HFSS can automatically save models at specified intervals.

To save the new project:

**1** Click **File>Save As**.

The **Save As** dialog box appears.

**2** Use the file browser to find the directory where you want to save the file.

**3** Type the name `rsc_example` in the **File name** text box.

**4** In the **Save as type** list, click **Ansoft HFSS Project (.hfss)** as the correct file extension for the file type.

When you create an HFSS project, it is given a `.hfss` file extension by default and placed in the **Project** directory. Any files related to that project are stored in that directory.

**5** Click **Save**.

HFSS saves the project to the location you specified.

**Note** For further information on any topic in HFSS, such as coordinate systems and grids or 3D Modeler commands or windows, you can view the context-sensitive help:

- Click the **Help** button in a pop-up window.
- Press **Shift+F1**. The cursor changes to **?**. Click on the item with which you need help.
- Press **F1**. This opens the Help window. If you have a dialog open, the Help opens to a page that describes the dialog.
- Use the commands from the **Help** menu.

## Select the Solution Type

Before you draw the RCS model, first you must specify a solution type. As you set up your model, available options will depend on the design's solution type.

To specify the solution type:

- 1 Click **HFSS>Solution Type**.

The **Solution Type** window appears.

- 2 This antenna project is a mode-based problem; therefore, select the **Driven Modal** solution type.

The possible solution types are described below.

**Driven Modal** For calculating the mode-based S-parameters of passive, high-frequency structures such as microstrips, waveguides, and transmission lines, which are "driven" by a source, and for computing incident plane wave scattering.

**Driven Terminal** For calculating the terminal-based S-parameters of passive, high-frequency structures with multi-conductor transmission line ports, which are "driven" by a source.  
Results in a terminal-based description in terms of voltages and currents.

**Eigenmode** For calculating the eigenmodes, or resonances, of a structure. The Eigenmode solver finds the resonant frequencies of the structure and the fields at those resonant frequencies.

- 3 Click **OK** to apply the **Driven Modal** solution type to your design.

## Set Up the Drawing Region

The next step is to set up the drawing region. For this RCS problem, you decide the coordinate system, and specify the units and grid settings.

## Coordinate System Settings

For this RCS problem, you will use the fixed, default global coordinate system (CS) as the working CS. This is the current CS with which objects being drawn are associated.

HFSS has three types of coordinate systems that let you easily orient new objects: a *global* coordinate system, a *relative* coordinate system, and a *face* coordinate system. Every CS has an x-axis that lies at a right angle to a y-axis, and a z-axis that is perpendicular to the xy plane. The origin (0,0,0) of every CS is located at the intersection of the x-, y-, and z-axes.

## Units Settings

Now, specify the drawing units for your model. For this antenna problem, set the drawing units to meter.

To set the units:

- 1** Click **Modeler>Units**.

The **Set Model Units** dialog box appears.

- 2** Select **meter** from the **Select units** menu. Make sure **Rescale to new units** is cleared.

If selected, the **Rescale to new units** option automatically rescales the grid spacing to units entered that are different than the set drawing units.

- 3** Click **OK** to accept meters as the units for this model.



## Create the Geometries

The geometries for this RCS model consists of the basic objects listed below with their dimensions:

<b>target</b>	A pec box .75 meter square. At the 300 Mhz Frequency we use in the simulation, this is $0.75\lambda$
<b>air box</b>	A vacuum box 1.4 meter square. This meets the requirement that PML boundaries should be at least $\lambda/4$ from the target.

## Create the Target Box

To create the target box, use the **Draw>Box** command to create a random box, and edit the properties for the following position and dimensions:

Coordinates	-0.375, -0.375, -0.375
XSize	0.75
YSize	0.75

## Set the Properties for the Target Box

To set the properties for the box:

- 1 Select the newly created box in the history tree, and right click **Properties** from the shortcut menu.  
This displays the **Properties** dialog.
- 2 Edit the name field to target.
- 3 In the materials field, press the button to display the **Materials library** dialog.
- 4 Select pec from the materials list, and click **OK** to close the dialogue.
- 5 In **Properties** dialogue for the box, **Edit** the color as a dark red.
- 6 Set the transparency as 0.6.
- 7 Click **OK** to accept the settings and close the dialog.

## Create the Air Box

To create the air box, use the **Draw>Box** command to create a random box, and edit the properties for the following position and dimensions:

Coordinates	-0.7, -0.7, -0.7
XSize	1.4
YSize	1.4

These dimensions will give the air box a suitable distance from the target, greater than  $\lambda/4$  wavelength on each side, relative to the 300 Mhz frequency we will use.

## Set the Properties for the Air Box

To set the properties for the air box:

- 1** Select the newly created box in the history tree, and right click **Properties** from the shortcut menu.

This displays the **Properties** dialog.

- 2** Edit the name field to `air_box`.
- 3** In the materials field, press the button to display the **Materials library** dialog.
- 4** Select vacuum from the materials list, and click **OK** to close the dialogue.
- 5** In **Properties** dialogue for the box, Edit the color as a light blue.
- 6** Set the Transparency as 0.8.
- 7** Click **OK** to accept the settings and close the dialog.

## Create the PML Boundaries

To create the PML boundaries:

- 1 Set the selection options to Face, either with the menu command **Edit>Select>Face**, the toolbar drop down menu for Face, or the F quick key.
- 2 Select **Edit>Select>By Name**, or click the select icon in the toolbar.

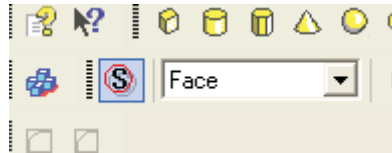

This displays the Select by Face dialog.

- 3 From the Object list, select `air_box`.  
This lists the names of the `air_box` faces.
- 4 Hold down the Ctrl key, and click each face.

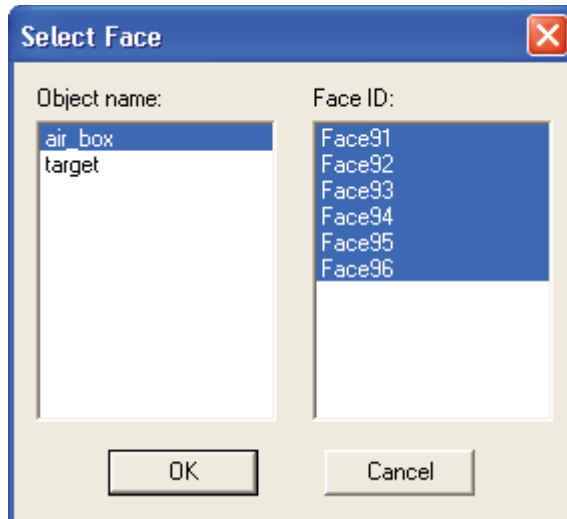

All faces of the airbox should be highlighted.

- 5 In the Modeler window, right click to display the shortcut menu, and select **Assign Boundary> PML Setup Wizard**.

The setup wizard displays.

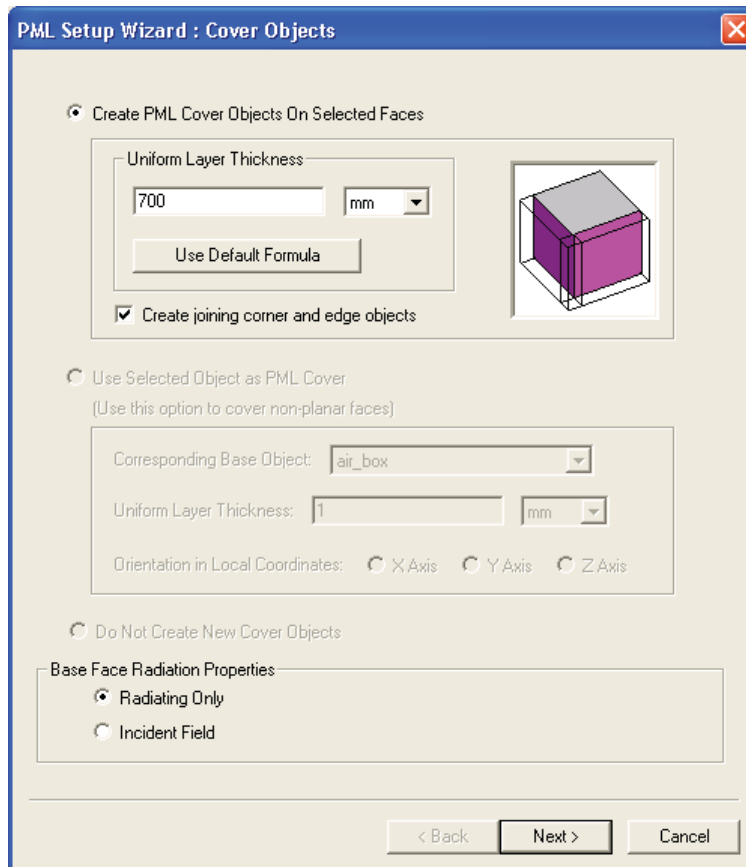

- 6 In the Uniform Layer Thickness field, set the thickness to 0.4 meter. This will keep the solution small enough for this exercise. The layers' material parameters will be adjusted

automatically in accordance with the new thickness.

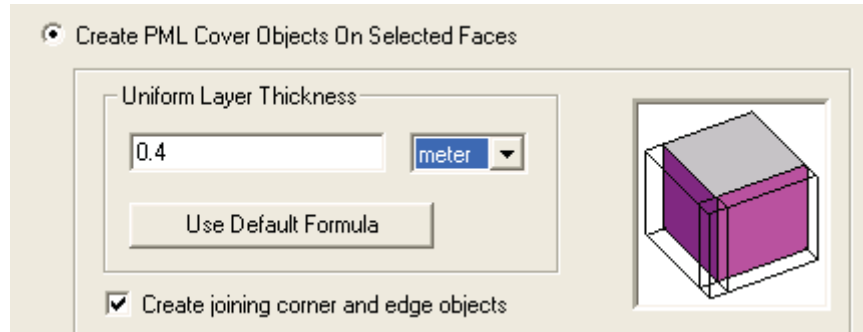

- 7 Leave the Create joining corner and edge objects checkbox selected, and click **Next**.

This creates the PML objects, and displays the **Material**

Parameters dialog.

PML Setup Wizard : Material Parameters

PML Objects Accept Free Radiation

Min Frequency: 0.3 GHz

PML Objects Continue Guided Waves

Propagation Constant at Min Frequency: 20 1/m

Minimum Radiating Distance:

0.3 meter Use Default Formula

< Back Next > Cancel

- 8 Set the Minimum Frequency to 0.3 Ghz, and the Minimum Radiating Distance to 0.3 meter, as shown.

9 Click Next to display the PML Summary dialog.

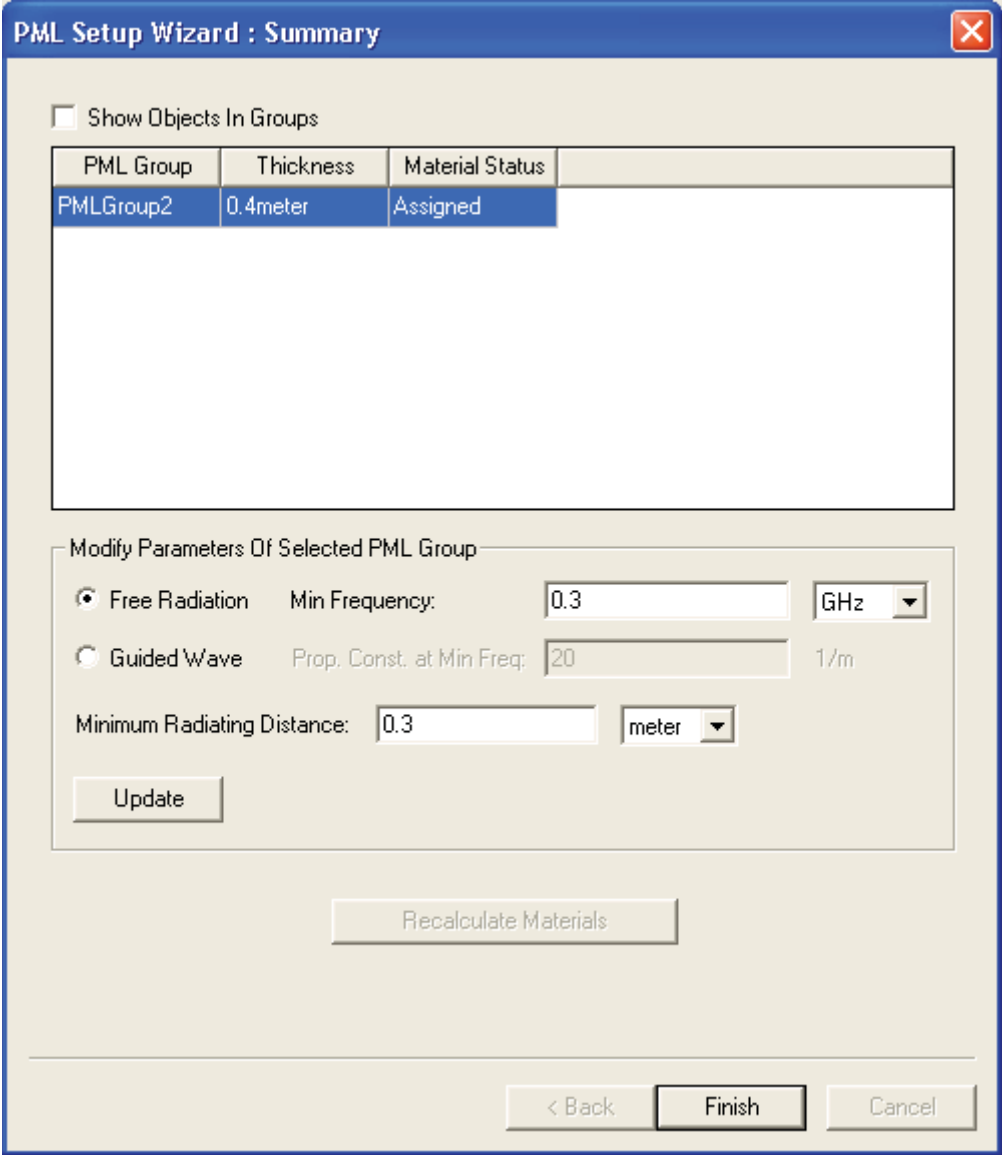

10 Click Finish to close the dialog.

The PML boundaries are listed under Boundaries in the Project tree, and the PML objects are listed in the History tree.

## Seed the Mesh on the Airbox

Seed the mesh on the air\_box to  $\lambda/5$ . This will result in a very accurate radiation pattern.

- 1 Select the faces of the air\_box
- 2 Right click on **Mesh Operations** in the Project tree.
- 3 Click **Assign>On Selection>Length Based**.  
This displays the **Element Length Based Refinement** dialog.

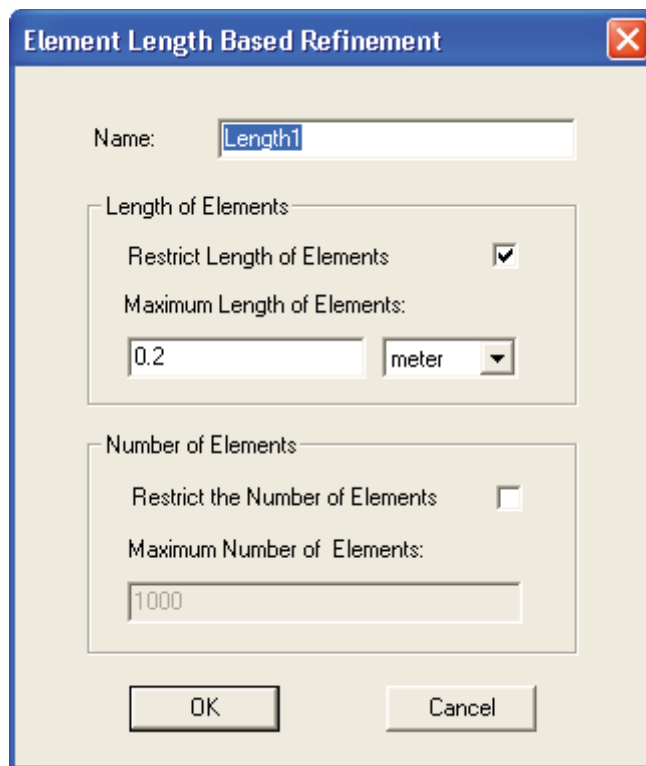

- 4 Set the Maximum length of Elements value to 0.2 with the units as meter.
- 5 Click OK to close the dialog.  
The Length1 icon appears under **Mesh Operations** in the Project tree.



## Add the Incident Plane Wave

An incident plane wave is a wave that propagates in one direction and is uniform in the directions perpendicular to its direction of propagation.

- 1** Click HFSS>Excitations>Assign>Incident Wave>Plane Wave.

The **Incident Wave Source: General Data** page appears.

- 2** Type the source's name in the **Name** text box or accept the default name.
- 3** Select the **Vector Input Format** as **Spherical** coordinates.
- 4** Enter 0, 0, 0 for the X-, Y-, and Z-coordinates of the **Excitation Location and/or Zero Phase Position** (the origin for the incident wave).
- 5** Click **Next**.
- 6** The **Incident Wave Source: Spherical Vector Setup** page appears.
  - a.** Under **IWaveTheta**, enter 0 deg for **Start**, 90 deg for **Stop**, and 3 for **Step**. For the monostatic case, the RCS will be computed only at values of **IWave  $\theta$**  entered here. For the purposes of this demo, this keeps the number points down and to save on the solution time
  - b.** Click **View Point List** to see the values of  $\theta$ .
- 7** Click **Next**. the **Incident Wave Source: Plane Wave Options** page appears.
- 8** Select the **Type of Plane Wave**.
- 9** Select **Regular/Propagating**, so no other fields are active.
- 10** Click **Finish**. The incident wave you defined is added to the **Excitations** list in the Project.



# 3

## Set Up and Generation Solutions

In this chapter you will complete the following tasks:

- ✓ Add a solution setup.
- ✓ Add a frequency sweep to the solution setup.
- ✓ Validate the design.
- ✓ Run the analysis.

## Add a Solution Setup to the Design

Specify how HFSS will compute the solution by adding a *solution setup* to the design.

In the solution setup, you will instruct HFSS to perform an adaptive analysis at 10 GHz. During an adaptive analysis, HFSS refines the mesh iteratively in the areas of highest error.

- 1** In the project tree, under the rcs\_example design, right-click **Analysis**, and then click **Add Solution Setup**  on the shortcut menu.

The **Solution Setup** dialog box appears.

- 2** Under the **General** tab, type **0.3** in the **Solution Frequency** text box, and leave the default unit set to **GHz**.
- 3** Leave the **Maximum Number of Passes** set to **6**. This is the maximum number of mesh refinement cycles that HFSS will perform.
- 4** Leave **Maximum Delta energy** at **0.1**.
- 5** Leave the default settings and click **OK**.

The solution setup is listed in the project tree under **Analysis**. It is named *Setup1* by default.



## Validate the Design

Before you run an analysis, it is helpful to verify that all of the necessary setup steps have been completed and their parameters are reasonable.

- 1 On the HFSS menu, click **Validation Check** .

HFSS checks the project setup, and then the **Validation Check** window appears.

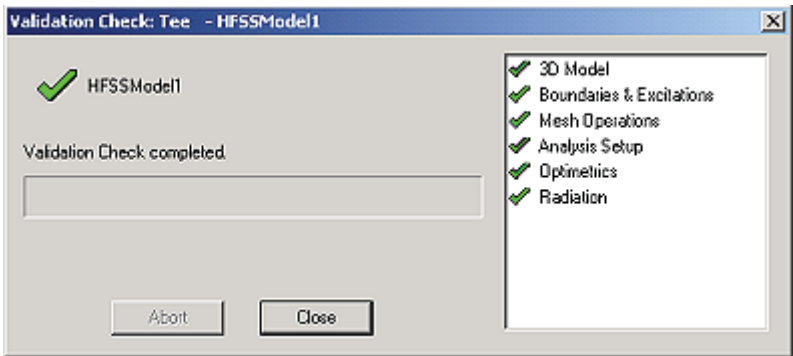

- 2 Click **Close**.

Now you are ready to run the simulation.

## Analyze the Design

Now you will run the simulation.

- On the HFSS menu, click **Analyze All** .

HFSS computes the 3D field solution for every solution setup in the project. In this problem, Setup1 is the only setup.

The solution process is expected to take approximately 5 to 30 minutes, depending on the machine speed and load.

When the solution is complete, a confirmation message appears in the **Message Manager**.

The **Progress** window displays the solution progress as it

OCCURS:

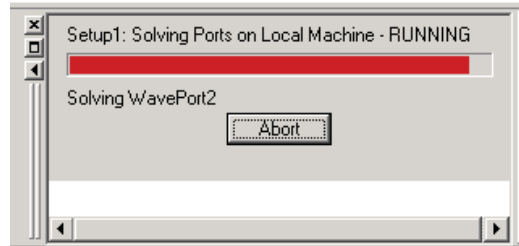

**Note** The results that you obtain should be approximately the same as the ones given in this section. However, there may be a slight variation between platforms.

### View the Solution Data

While the analysis is running, you can view a variety of profile, convergence, and matrix data about the solution.

### View the Profile Data

While the solution proceeds, examine the computing resources, or profile data, used by HFSS during the analysis. The profile data is essentially a log of the tasks performed by HFSS during the solution. The log indicates the length of time each task took and how much RAM/disk memory was required.

# 4

## Post Processing for RCS

This chapter describes how to create the geometry setups for monostatic and bistatic infinite spheres. You can then create plots for these geometries for a Normalized Bistatic RCS and Monostatic RCS. Normalized RCS means RCS normalized with respect to wavelength squared.

## Creating the Far Field Infinite Sphere Setups

To evaluate radiated fields in the far-field region, you must set up an infinite sphere that surrounds the radiating object. For this example, we will create setups for the bistatic and monostatic cases.

When you set up a spherical surface over which to analyze near or far fields, you specify a range and step size for phi and theta. These indicate the spherical direction in which you want to evaluate the radiated fields. For every value of phi there is a corresponding range of values for theta, and vice versa. This creates a spherical grid. Each grid point indicates a unique direction along a line that extends from the center of the sphere through the grid point. The radiated field is evaluated in this direction. The number of grid points is determined by the step size for phi and theta.

The sphere can be defined according to any defined coordinate system and before or after a solution has been generated.

The relationship between phi and theta is shown below.

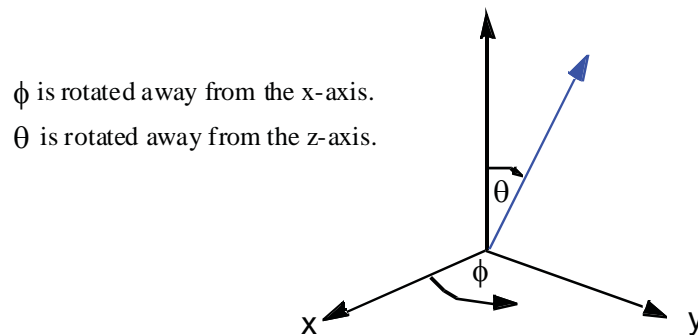

When HFSS evaluates the radiated fields, it needs at least two directions along which to plot the fields. Therefore, if the step size for phi is zero, then the step size for theta must be greater than zero, and vice versa. This ensures that the fields are plotted in at least two directions.



## Creating the Monostatic Setup

- 1 Click HFSS>Radiation>Insert Far Field Setup>Infinite Sphere.

The Far Field Radiation Sphere Setup dialog appears.

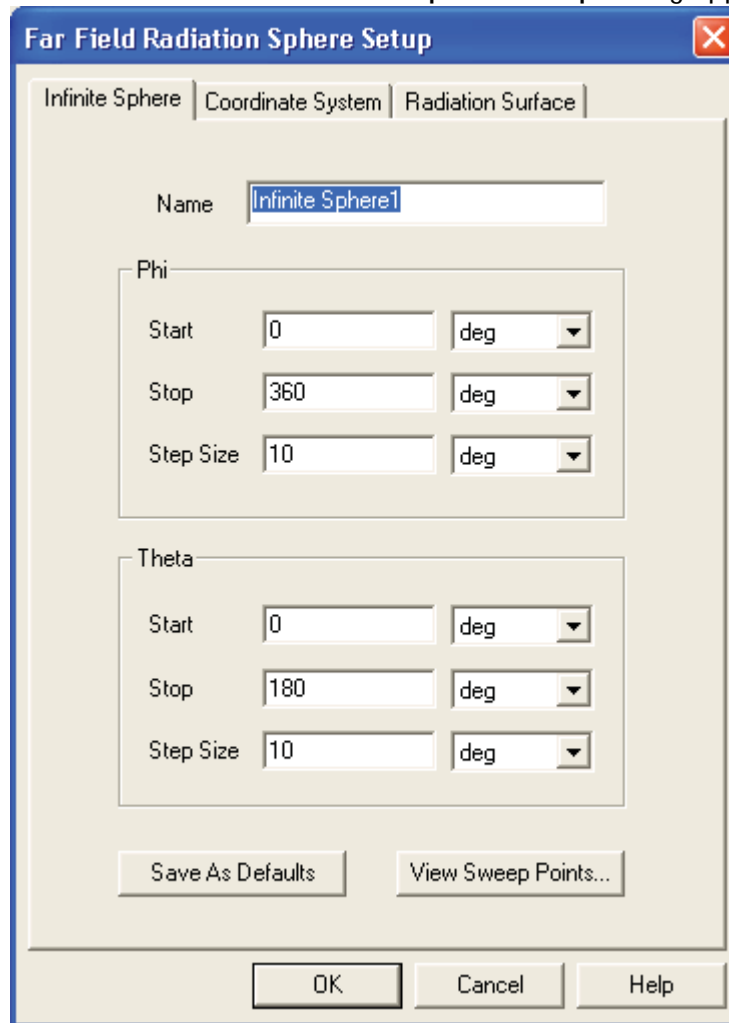

- 2 Under the **Infinite Sphere** tab, type a name for the sphere in the **Name** text box.  
For the monostatic sphere, type the name **monostatic**.
- 3 Specify the range of angles to include in the sphere. For the monostatic case, **phi** and **theta** will be dummy values.

## Getting Started with HFSS: RCS

---

The reason is that when we ask, later, for a plot of monostatic RCS, the software will know in which direction to compute the far field for every incident angle: *iwavetheta* and *iwavephi* from the excitation setup.

- a. Specify the following for **Phi**, in degrees (**deg**) or radians (**rad**):

<b>Start</b>	The point where the rotation of phi begins. Leave this as 0.
<b>Stop</b>	The point where the rotation of phi ends. The <b>Stop</b> value must be greater than or equal to the <b>Start</b> value and less than 360. If the <b>Stop</b> value is equal to the <b>Start</b> value, then HFSS assumes that only one angle should be used and the <b>Step Size</b> value will be ignored. Set this to 0.
<b>Step Size</b>	The number of degrees or radians (spherical grid points) between the sweep of phi. Entering zero for the <b>Step Size</b> causes the sweep to consist of one point, the start value. If the <b>Step Size</b> value is zero, then HFSS assumes that only one angle should be used. Set this to 0.

- b. Specify the following for **Theta**, in degrees (**deg**) or radians

(rad):

- |                  |  |
|------------------|--|
| <b>Start</b>     | The point where the rotation of theta begins. The <b>Start</b> value must be greater than -90 degrees, or the equivalent in radians.<br>Set this to 0.   |
| <b>Stop</b>      | The point where the rotation of theta ends. The <b>Stop</b> value must be greater than the <b>Start</b> value and less than 90 degrees, or the equivalent in radians. If the <b>Stop</b> value is equal to the <b>Start</b> value, HFSS assumes that only one angle should be used and the <b>Step Size</b> value will be ignored.<br>Set this to 0. |
| <b>Step Size</b> | The number of degrees or radians (spherical grid points) between the sweep of theta.<br>Entering zero for the number of steps causes the sweep to consist of one point, the <b>Start</b> value. If the <b>Step Size</b> value is zero, then HFSS assumes that only one angle should be used.<br>Set this to 0.                                       |

- 4 Click the **Coordinate System** tab, and then to orient the sphere according to the global coordinate system (CS), select **Use global coordinate system**.
  - If you needed to orient the sphere according to a user-defined CS, you would select **Use local coordinate system** and then select a defined CS from the **Choose from existing coordinate systems** list.
- 5 Click the **Radiation Surface** tab.  
Leave the selection as **Use Boundary Radiation Surfaces**. If you needed to specify a surface other than an assigned radiation or PML boundary over which to integrate the radiated fields, you could select **Use Custom Radiation Surface**.
- 6 Click **OK**.  
The monostatic infinite sphere is created. It is listed in the

project tree under Radiation.

**Note** You must have defined at least one radiation or PML boundary in the design for HFSS to compute far-field quantities, regardless of which radiation surfaces you instruct HFSS to use when calculating the far fields. You do not need to re-solve the problem if you modify radiation surfaces in the Far Field Radiation Sphere Setup window.

### Creating the Bistatic Setup

- 1** In the Project tree, right-click on Radiation and from the short cut menu click **Insert Far Field Setup>Infinite Sphere**.

The Far Field Radiation Sphere Setup dialog appears.

- 2** This time specify the name as bistatic.
- 3** Set the Phi Start, Stop, and Step values as 0.
- 4** Set the Theta Start value as 0, the Stop value as 180 deg and the Step values as 1.
- 5** Click **OK** to close the dialog.  
The bistatic setup appears under **Radiation** in the Project tree.

## Creating a Far-Field Plot for Bistatic RCS

First, create a plot for bistatic RCS.

To select a far-field quantity to plot:

- 1** To create the report, right-click on the Results icon in the Project tree, and select **Create Far Fields Report>Rectangular Plot**.

This displays the **New Report - New Traces** dialog.

- 2** Leave the Context selection for the Solution as Setup1: LastAdaptive.
- 3** In order to plot the RCS, you select one of the geometries you created from the **Geometry** list in the Traces dialog. For this plot, select **Bistatic** as the Geometry.
- 4** For Category, select **Normalized Bistatic RCS**.  
This selection causes the **Quantity** list to show NormRCS quantities for Total, Phi, Theta, X, Y, and Z, with Total Selected.
- 5** For the function, select **dB** function.

After these sections, the Y field under Trace shows db(NormRCSTotal). The X value will be the Theta for the

incident wave defined for the simulation

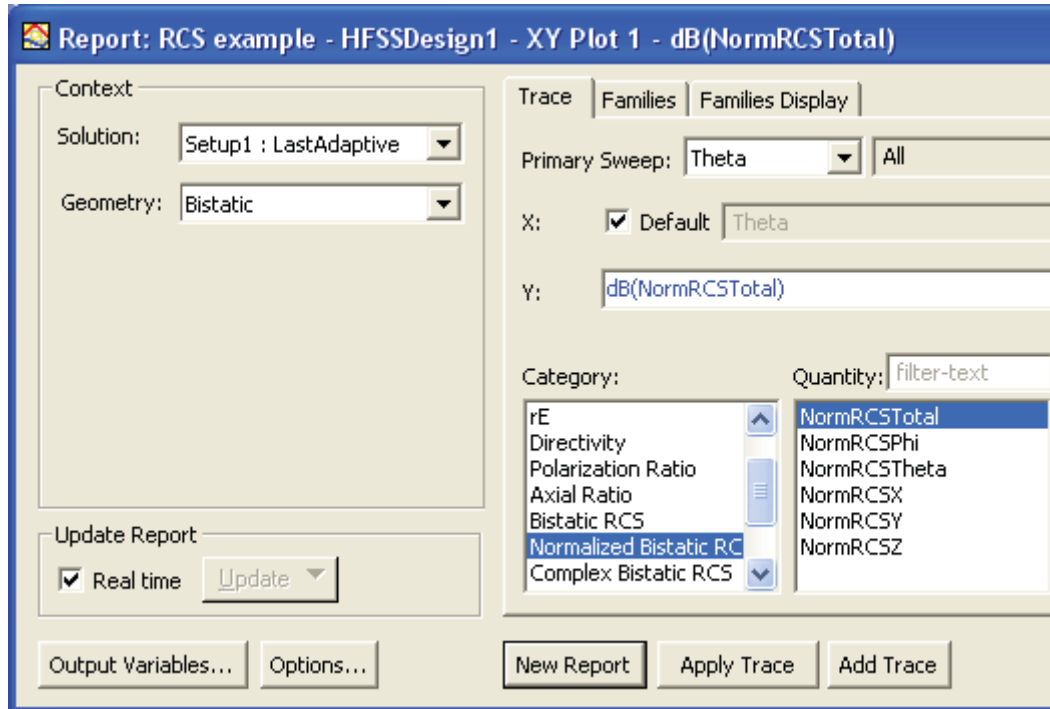

- 6 Click on the **Families** tab and verify that  $IWaveTheta=0$ , meaning that of all the incident waves, we are going to plot the bistatic pattern of this one only.
- 7 Click **New Report**.  
This generates the report, adding it to the Project tree, and causes it to display.

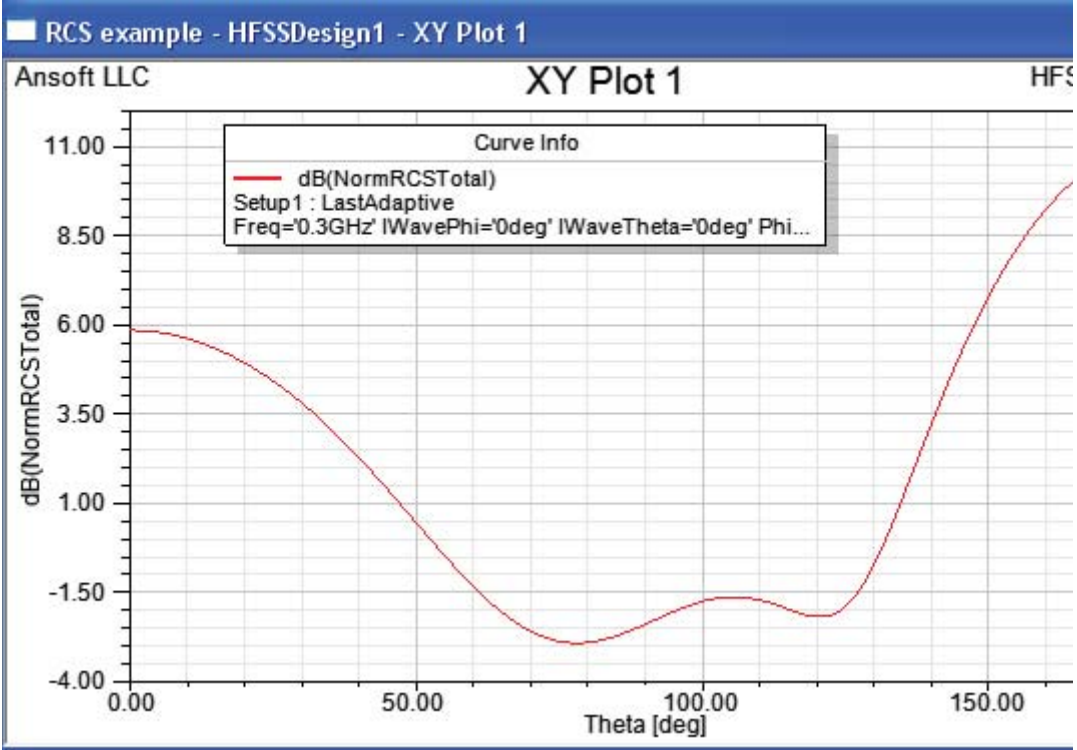

8 Click Close to close the Report.

## Creating a Plot for Monostatic RCS

The procedure for creating a Monostatic RCS plot is similar to that used for creating the Bistatic RCS plot.

- 1** Right-click on the Results icon in the Project tree, and select **Create Far Field Report>Rectangular Plot**.

This opens the **New Report - New Trace(s)** dialog.

- 2** For the **Context**, select **Monostatic** from the menu.
- 3** From **Category** list, select **MonostaticRCS**.
- 4** From the **Quantity** list, select **NormMonostaticRCSTotal** (You may need to scroll, or size the dialog to see.)
- 5** From the **Function** list, select **dB**.

The **Y** field for the Trace should show **dB(NormMonostaticRCSTotal)**.

- 6** Set the **X** field for the Trace as **IWaveTheta**.
- 7** Click **New Report**.

This generates the report, adding it to the Project tree,



and causes it to display.

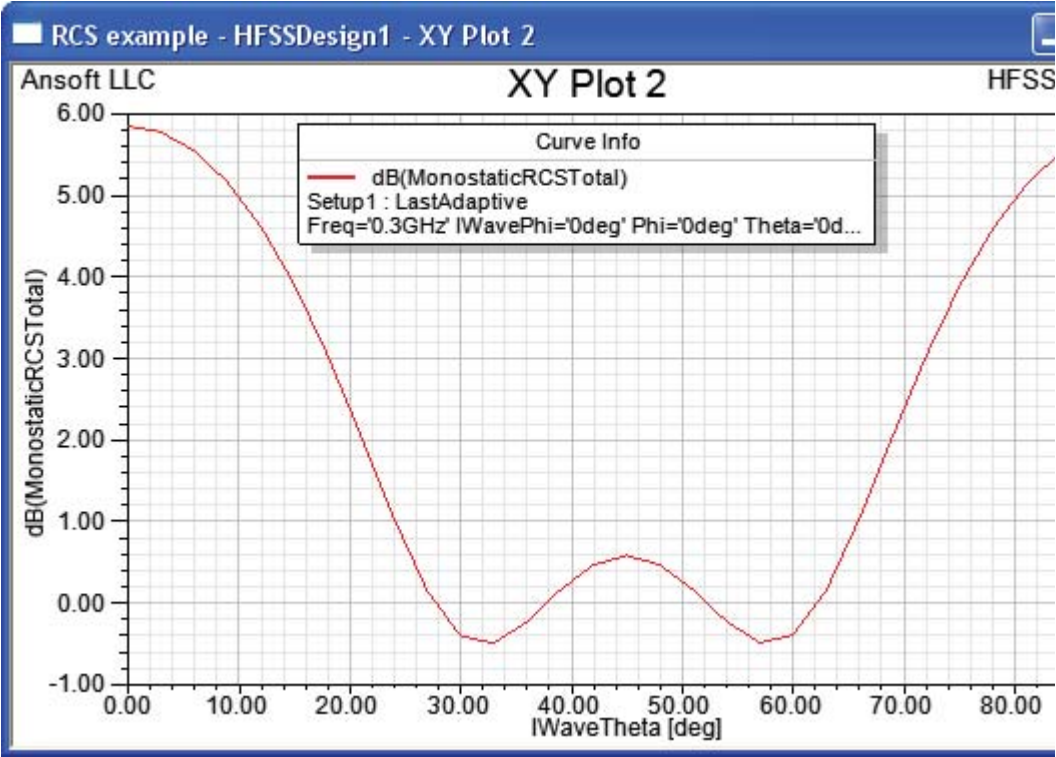

This completes the exercise. Save the project and exit.

